

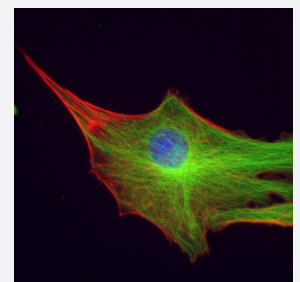

INVENIO 6EMIII CAMERA

- ▶ High resolution
- ▶ High Contrast
- ▶ Ultra sensitive
- ▶ High-speed live video
- ▶ High-quality Sony sensor

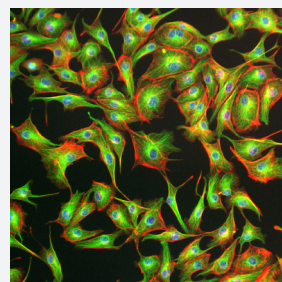
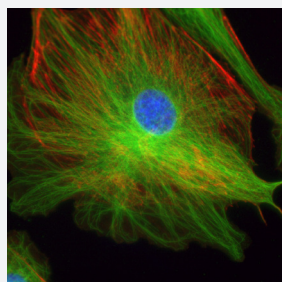
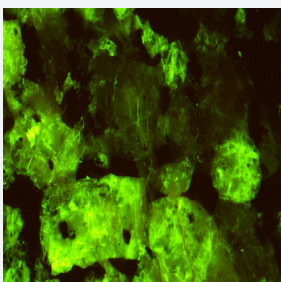

Invenio 6EMIII - Monochrome Camera

DeltaPix Invenio 6EMIII microscope cameras offer fast and precise high resolution live video stream as well as still images! User-friendly setup for everyday use, with a first in class price/performance ratio.

The Invenio 6EMIII camera is especially suited for low light applications, due to its high sensitivity, and applications in which high frame rate is required.

The Invenio 6EMIII camera is based on a high-quality Sony Exmor™ sensor for excellent image quality, sensitivity and speed.



High quality, cost effective and flexible

The Invenio EIII microscope camera series has C-mount interface making them easily and cost efficiently fitted on most standard microscopes.



User-friendly Camera

Plug and play – the USB 3.0 interface provides high speed and ease of installation on any computer.

No need for external power supply, because the Invenio EIII Microscope cameras uses the included USB cable for power, control and to data transition.



Typical applications: ✓ Material science ✓ Metrology ✓ Quality control ✓ Dark Field ✓ Bright Field ✓ Fluorescence ✓ Semiconductor inspection ✓ Cytology ✓ Biology

Spectral Sensitivity

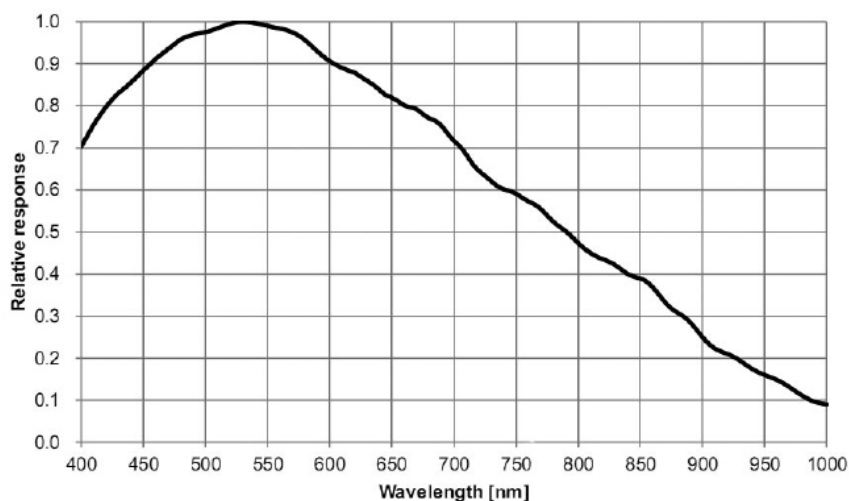

Why choose Invenio 6EMIII

Ultra-Low noise images

The Invenio 6EMIII Microscope camera is built with Sony's newest sensor, type Exmor™ which is a superior sensor type especially for one reason: The Exmor™ sensors digitize the pixels before the column signals are multiplexed, thereby minimizing the noise signal significantly compared to standard CMOS sensors.

Camera construction

There is a huge difference between so called "machine vision cameras" and cameras designed and build for microscopy. In most Machine vision applications, "details" as colors, hot pixels, dust particles, user friendliness and likewise, does not matter much, as it's a machine which are looking at the images/video stream. For a dedicated microscope camera all these details matters a lot. A microscope camera is typically physical larger in order to adapt more heat, keeping the sensor cool. The IR filter is of higher quality, free from small scratches and holes, which could create shadows in the image (DeltaPix inspects all filter and sensors surfaces carefully, a process which can last up to 2 hours. Around 20% of all filters are discarded during this process). Also even extremely small dust particles can create dark shadows in the image of a camera used for microscopy. For this reason, all DeltaPix Microscope cameras are manufactured by DeltaPix in a dust free clean chamber to achieve unmatched clear, sharp and crisp images.

Smear-free images.

The special construction of the Exmor™ sensor allows the sensor to produce smear-free images like other noname CMOS sensors, but without the limited dynamic range and contrast know from traditional CMOS sensors.

DeltaPix InSight Software

The Invenio 6EMIII camera Include DeltaPix InSight which is a powerful platform for precise measurements and analyses.

DeltaPix InSight allows expansion with a multitude of modules, for a wide range of advanced applications with an easy-to-use user interface. Available modules for example images stacking, HDR for wide dynamic images, 3D measurements/ 3D topography, Roughness measurement, stitching, Object Counting and much more.

Camera Dimensions

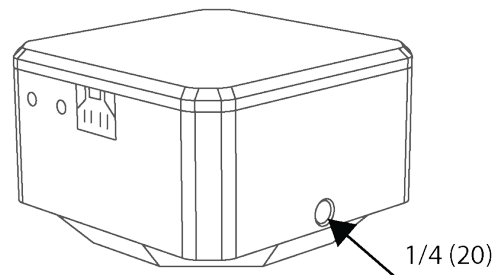
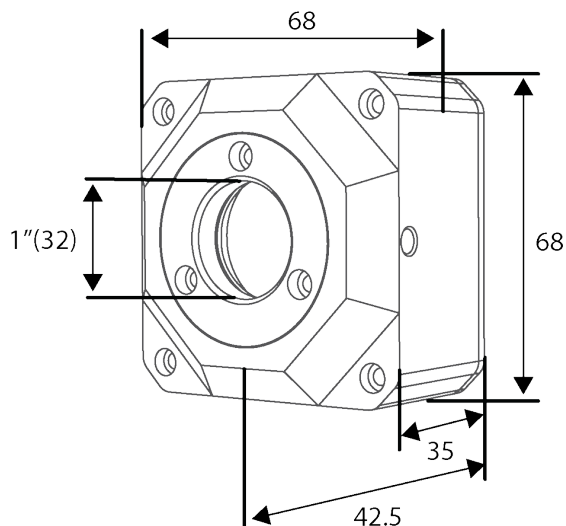

Invenio 6EMIII - Monochrome camera

Features

| | Invenio 6EMIII - Monochrome |
|-----------------------------|---|
| Live preview resolution | 3072 x 2048 @15FPS 1536 x 1024 @25FPS |
| Still image resolution | 6.3Mpixels (3072x2048) 1.57Mpixels(1536 x 1024) |
| Sensor size | 1/1.8" Sony Exmor 7.37mm x 4.92mm |
| Pixel size | 2.4µm x 2.4µm |
| Exposure time | 0.244 milliseconds – 2000 milliseconds |
| Gain | 1-50 |
| Sensitivity | 425mv with 1/30s |
| Shutter | Electronic rolling shutter |
| Exposure mode | Automatic or Manual |
| Color balance | Automatic, manual or spot with balance |
| Data interface | USB 3.0 |
| Data format and compression | 24-bit uncompressed Tiff, 24bit JPEG compressed and 24-bit loss-less compressed JPEG2000 24bit uncompressed video AVI format. |
| Minimum PC requirements | Intel I5 (quad core) CPU 4 GB RAM 15 GB free hard disk space USB 3.0 port Windows 7,8 ,10 32bit and 64 bit |
| Optional | Software Developer Kit (SDK) for developing deep integration with other software applications. Twain Driver |

DeltaPix Aps, Hassellunden 16,
DK-2765 Smorum Denmark
Telephone:+45 46760205
E-mail: deltapix@deltapix.dk